



SALVACLIMA

PERSIANA / SCURO

SISTEMA
Salvaclima[®]
MONOBLOCCHI TERMOACUSTICI

PERSIANA / SCURO CON CARDINE

Intonaco	124
Cappotto	126
Facciata Ventilata	128

PERSIANA / SCURO CON TELAIO

Intonaco	130
Cappotto	132
Mattone Facciavista	134

PERSIANA / SCURO PERSIANA / GRATA ECO

Intonaco	136
Cappotto	138
Mattone Facciavista	140

PERSIANA / SCURO COMBINATA ECO

Intonaco	142
Cappotto	144
Mattone Facciavista	146

MONOBLOCCO

Serramento Con cardine
Finitura Esterna Intonaco

ESEMPIO
DI CONFIGURAZIONE
SPALLA 501 / 501Z
SOTTOBANCALE 201

SEZIONE VERTICALE

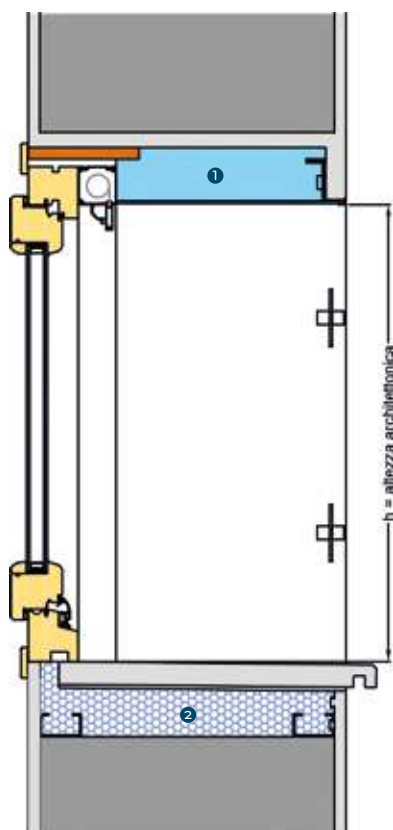

ELEMENTI

- 1 TRAVERSA
- 2 SOTTOBANCALE
- 3 SPALLA
- 4 PREDISPOSIZIONE ZANZARIERA
- 5 STAFFA 40/10 PORTA CARDINE

MATERIALI

- XPS CAM
- EPS CAM
- OSB
- FIBROCEMENTO
- INTONACO

SEZIONE ORIZZONTALE

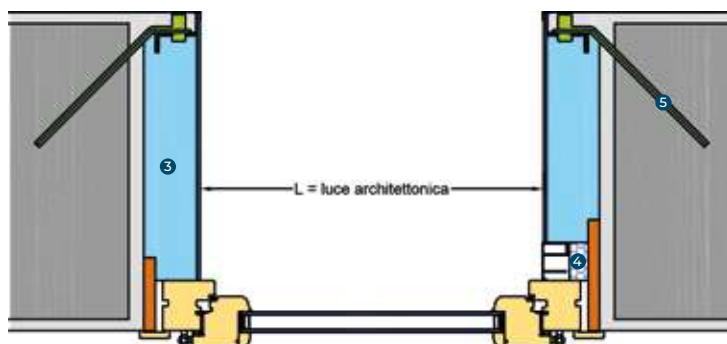

SPALLA

SPALLA STANDARD PREFINITA

MODELLO 501

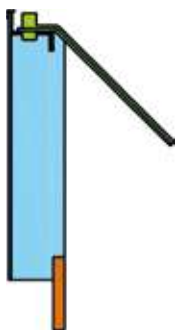

SPALLA RINFORZATA PREFINITA

MODELLO 541

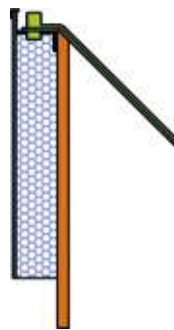

SPALLA RINFORZATA A RASARE

MODELLO 521

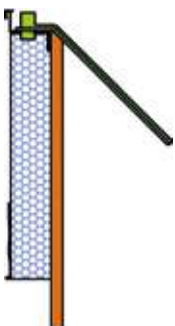

Z - SEDE ZANZARIERA

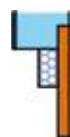

PREDISPOSIZIONE PER GRATA
(SOLO SPALLA RINFORZATA)

su spalla



SOTTOBANCALE

con fibrocemento

MODELLO 10F



senza fibrocemento

MODELLO 20I

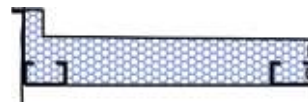

MODELLO 5

listello taglio termico



MONOBLOCCO

Serramento Con cardine
Finitura Esterna Cappotto

ESEMPIO
DI CONFIGURAZIONE
SPALLA 501 / 501Z
SOTTOBANCALE 20J

SEZIONE VERTICALE

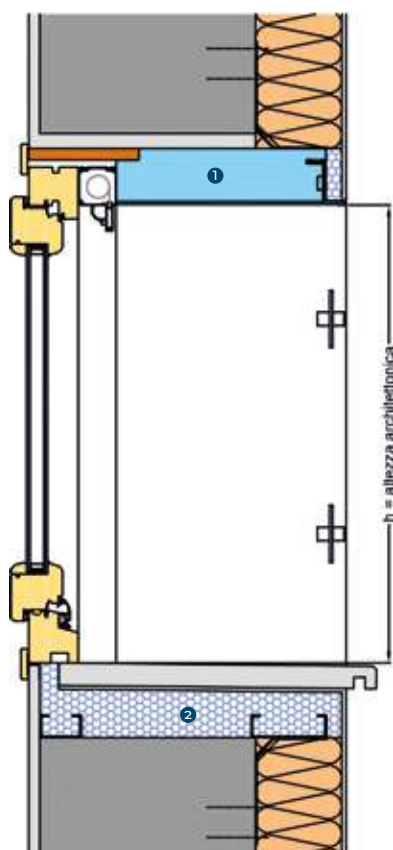

ELEMENTI

- 1 TRAVERSA
- 2 SOTTOBANCALE
- 3 SPALLA
- 4 PREDISPOSIZIONE ZANZARIERA
- 5 STAFFA 40/10 PORTA CARDINE

MATERIALI

- XPS CAM
- EPS CAM
- OSB
- FIBROCEMENTO
- CAPPOTTO

SEZIONE ORIZZONTALE

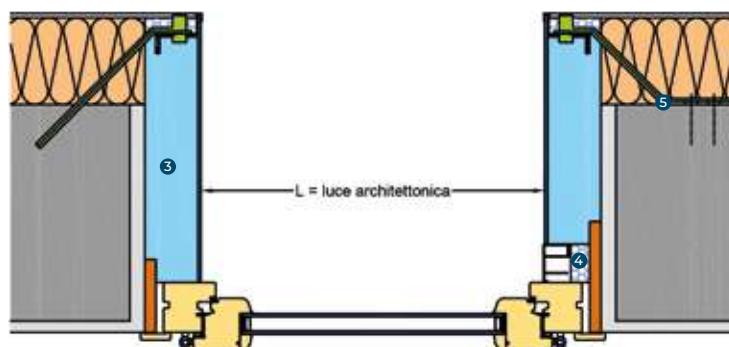

SPALLA

SPALLA STANDARD PREFINITA

MODELLO 501 MODELLO 501

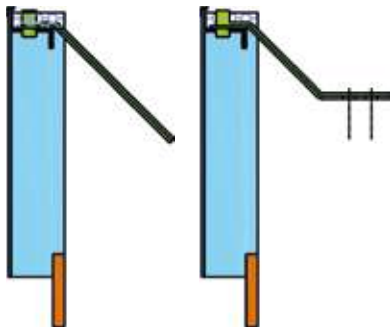

SPALLA RINFORZATA PREFINITA

MODELLO 541 MODELLO 541

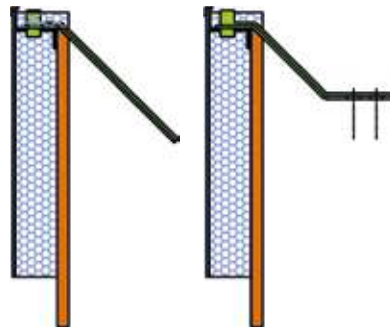

SPALLA RINFORZATA A RASARE

MODELLO 521 MODELLO 521

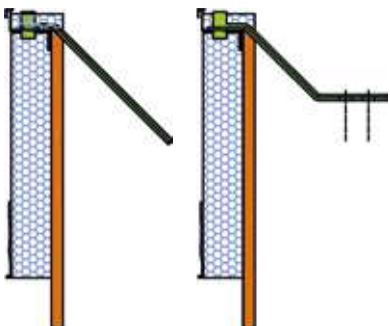

Z - SEDE ZANZARIERA

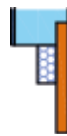

PREDISPOSIZIONE PER GRATA
(SOLO SPALLA RINFORZATA)

su spalla

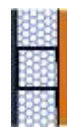

SOTTOBANCALE

con fibrocemento

MODELLO 10G

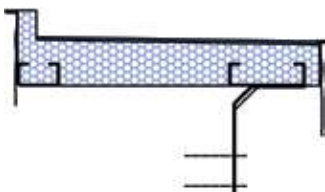

senza fibrocemento

MODELLO 20J

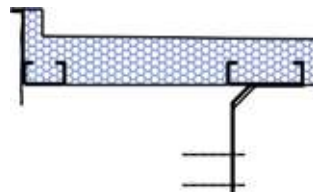

MODELLO 5

listello taglio termico

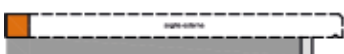

MONOBLOCCO

Serramento Con cardine
Finitura Esterna Facciata Ventilata

ESEMPIO
DI CONFIGURAZIONE
SPALLA 501 / 501Z
SOTTOBANCALE 20K

SEZIONE VERTICALE

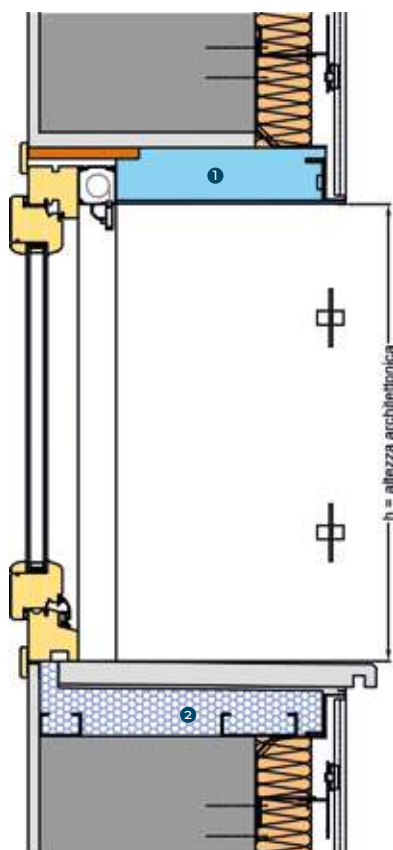

ELEMENTI

- 1 TRAVERSA
- 2 SOTTOBANCALE
- 3 SPALLA
- 4 PREDISPOSIZIONE ZANZARIERA
- 5 STAFFA 40/10 PORTA CARDINE

MATERIALI

- XPS CAM
- EPS CAM
- OSB
- FIBROCEMENTO
- CAPPOTTO

SEZIONE ORIZZONTALE

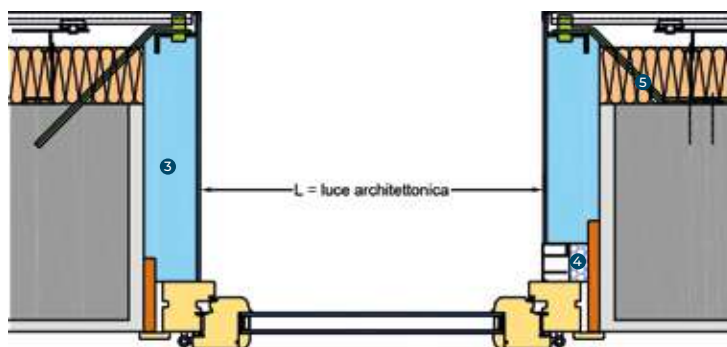

SPALLA

SPALLA STANDARD PREFINITA

MODELLO 501 MODELLO 501

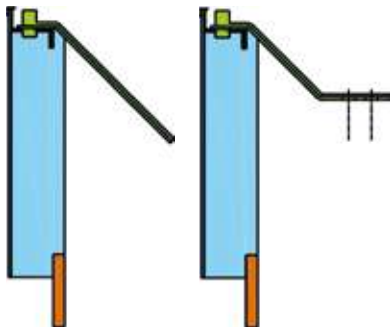

SPALLA RINFORZATA PREFINITA

MODELLO 541 MODELLO 541

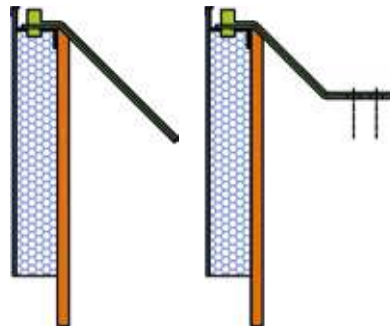

SPALLA RINFORZATA A RASARE

MODELLO 521 MODELLO 521

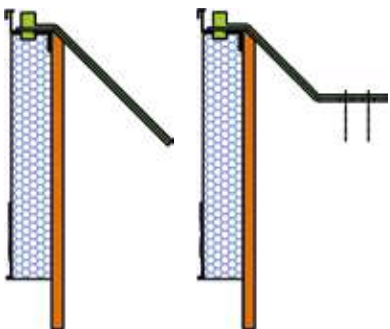

Z - SEDE ZANZARIERA

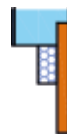

PREDISPOSIZIONE PER GRATA (SOLO SPALLA RINFORZATA)

su spalla



SOTTOBANCALE

con fibrocemento

MODELLO 10H

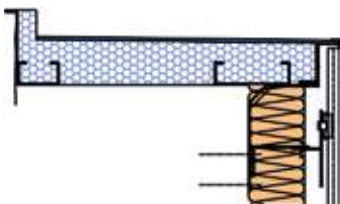

MODELLO 5
listello taglio termico



senza fibrocemento

MODELLO 20K

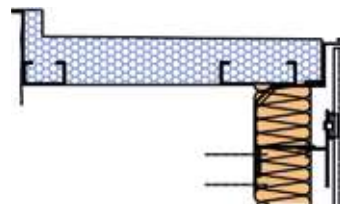

MONOBLOCCO

Serramento Con telaio
Finitura Esterna Intonaco

ESEMPIO
DI CONFIGURAZIONE
SPALLA 301 / 301Z
SOTTOBANCALE 201

SEZIONE VERTICALE

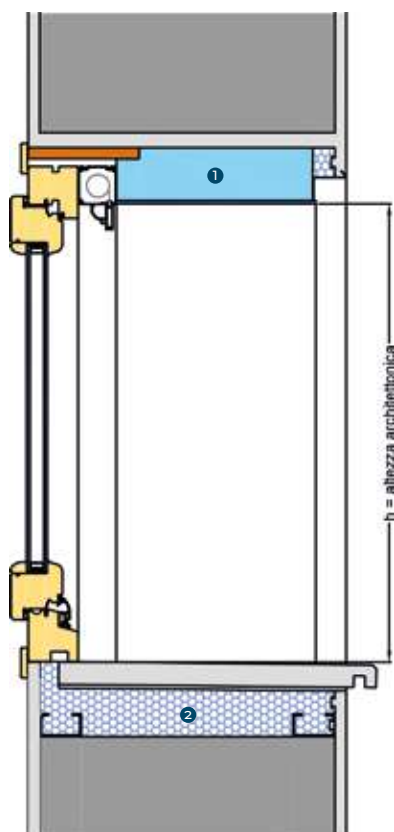

ELEMENTI

- ① TRAVERSA
- ② SOTTOBANCALE
- ③ SPALLA
- ④ PREDISPOSIZIONE ZANZARIERA

MATERIALI

- XPS CAM
- EPS CAM
- OSB
- FIBROCEMENTO
- INTONACO

SEZIONE ORIZZONTALE

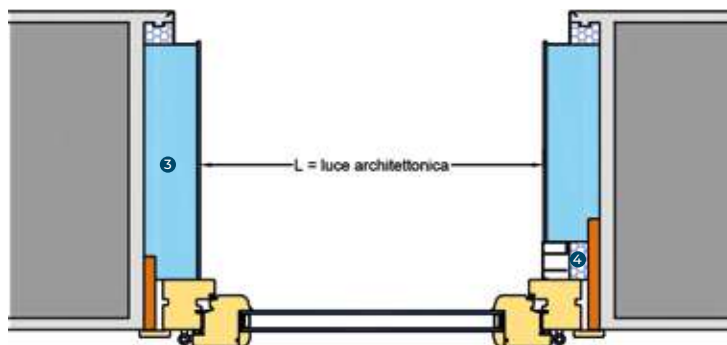

SPALLA

SPALLA STANDARD PREFINITA

MODELLO 301



SPALLA RINFORZATA PREFINITA

MODELLO 341



SPALLA RINFORZATA A RASARE

MODELLO 321

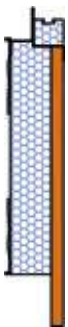

Z - SEDE ZANZARIERA

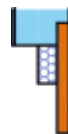

PREDISPOSIZIONE PER GRATA
(SOLO SPALLA RINFORZATA)

su spalla



SOTTOBANCALE

con fibrocemento

MODELLO 10F



senza fibrocemento

MODELLO 20I

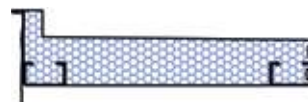

MODELLO 5

listello taglio termico



MONOBLOCCO

Serramento Con telaio
Finitura Esterna Cappotto

ESEMPIO
DI CONFIGURAZIONE
SPALLA 301 / 301Z
SOTTOBANCALE 20J

SEZIONE VERTICALE

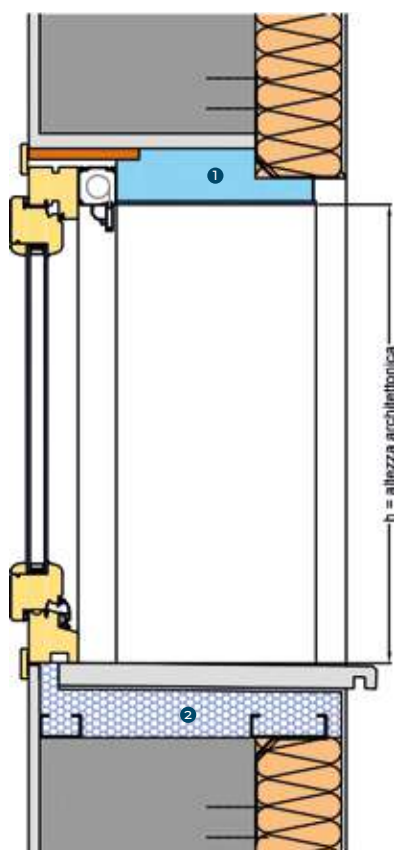

ELEMENTI

- ① TRAVERSA
- ② SOTTOBANCALE
- ③ SPALLA
- ④ PREDISPOSIZIONE ZANZARIERA
- ⑤ STAFFA DI FISSAGGIO

MATERIALI

- XPS CAM
- EPS CAM
- OSB
- FIBROCEMENTO
- CAPPOTTO

SEZIONE ORIZZONTALE

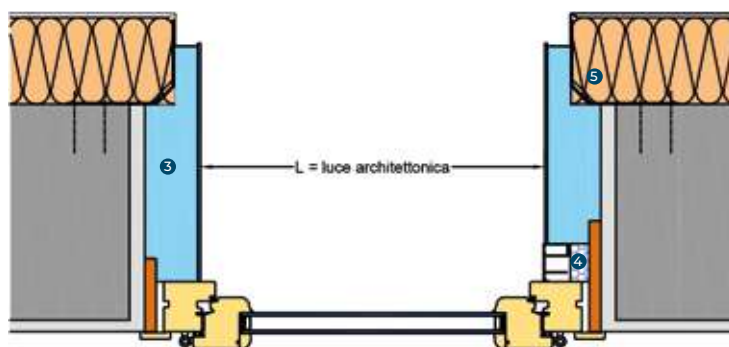

SPALLA

SPALLA STANDARD PREFINITA

MODELLO 301

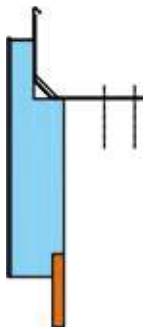

SPALLA RINFORZATA PREFINITA

MODELLO 341

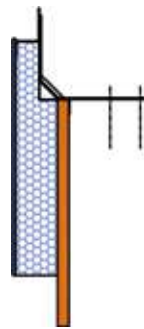

SPALLA RINFORZATA A RASARE

MODELLO 321

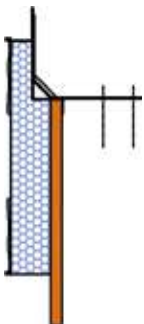

Z - SEDE ZANZARIERA

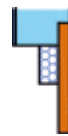

PREDISPOSIZIONE PER GRATA
(SOLO SPALLA RINFORZATA)

su spalla

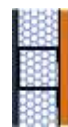

SOTTOBANCALE

con fibrocemento

MODELLO 10G

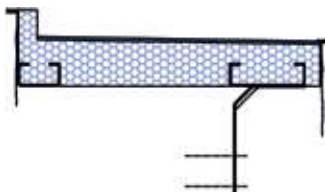

senza fibrocemento

MODELLO 20J

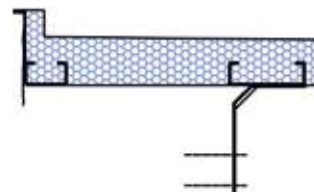

MODELLO 5

listello taglio termico

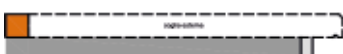

PERSIANA / SCURO

CON TELAIO

CAPPOTTO

MONOBLOCCO

Serramento Con telaio
Finitura Esterna Facciavista

ESEMPIO
DI CONFIGURAZIONE
SPALLA 301 / 301Z
SOTTOBANCALE 20

SEZIONE VERTICALE

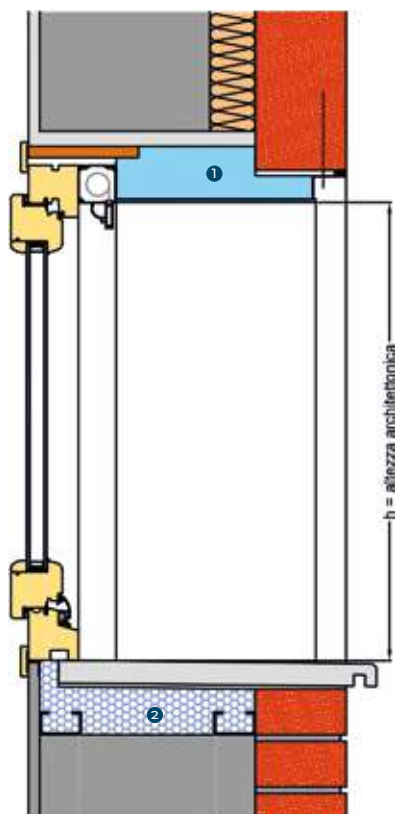

ELEMENTI

- ① TRAVERSA
- ② SOTTOBANCALE
- ③ SPALLA
- ④ PREDISPOSIZIONE ZANZARIERA

MATERIALI

- XPS CAM
- EPS CAM
- OSB
- FIBROCEMENTO
- MATTONE

SEZIONE ORIZZONTALE

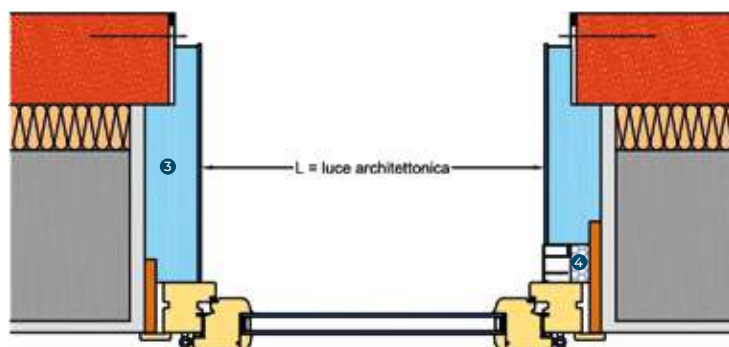

SPALLA

SPALLA STANDARD PREFINITA

MODELLO 301

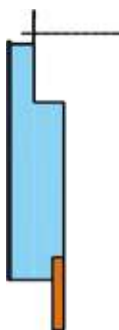

SPALLA RINFORZATA PREFINITA

MODELLO 341

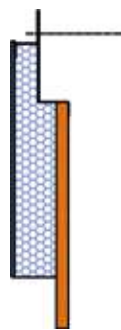

SPALLA RINFORZATA A RASARE

MODELLO 321



Z - SEDE ZANZARIERA

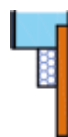

PREDISPOSIZIONE PER GRATA
(SOLO SPALLA RINFORZATA)

su spalla



SOTTOBANCALE

con fibrocemento

MODELLO 10

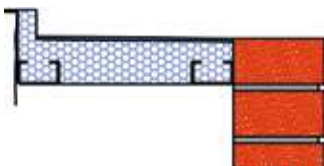

senza fibrocemento

MODELLO 20

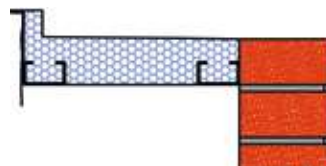

MODELLO 5

listello taglio termico

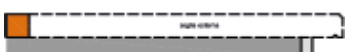

MONOBLOCCO

Serramento Persiana / Grata Eco
Finitura Esterna Intonaco

ESEMPIO
DI CONFIGURAZIONE
SPALLA 491 / 491Z
SOTTOBANCALE 201

SEZIONE VERTICALE

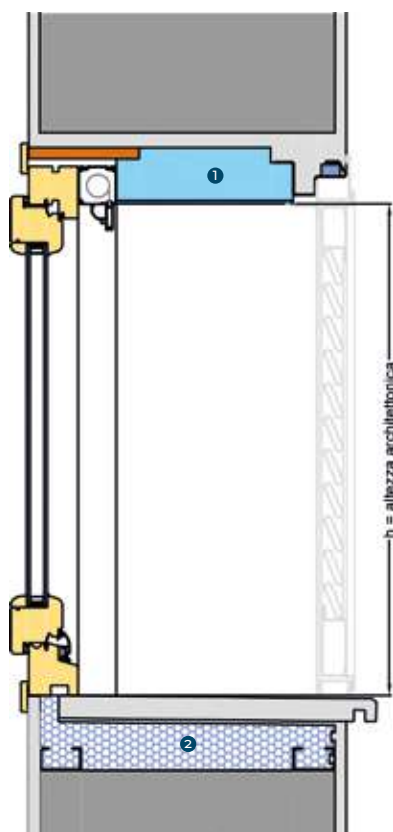

ELEMENTI

- ① TRAVERSA
- ② SOTTOBANCALE
- ③ SPALLA
- ④ PREDISPOSIZIONE ZANZARIERA

MATERIALI

- XPS CAM
- EPS CAM
- OSB
- FIBROCEMENTO
- INTONACO

SEZIONE ORIZZONTALE

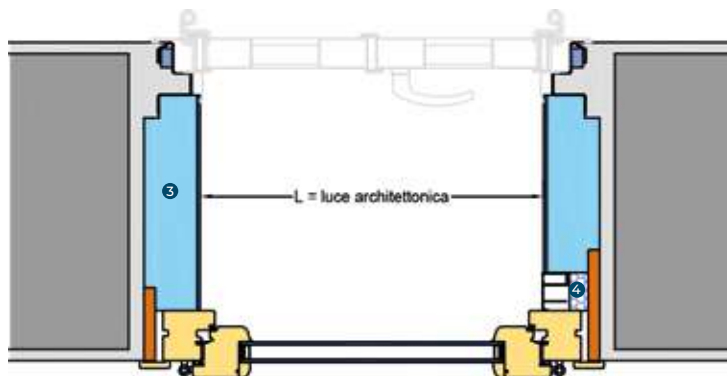

PAG. 171



PAG. 217



PAG. 201

SPALLA

SPALLA STANDARD PREFINITA

MODELLO 491



SPALLA RINFORZATA PREFINITA

MODELLO 441



SPALLA RINFORZATA A RASARE

MODELLO 421



Z - SEDE ZANZARIERA

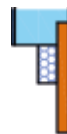

VARIANTE SENZA COPRIFILO
(Solo Persiane/Grate Eco apribili)



SOTTOBANCALE

con fibrocemento

MODELLO 10F



senza fibrocemento

MODELLO 20I

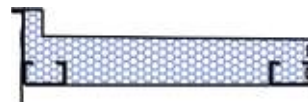

MODELLO 5

listello taglio termico

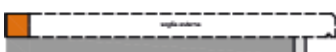

PERSIANA / SCURO

PERSIANA / GRATA ECO

INTONACO

MONOBLOCCO

Serramento Persiana / Grata Eco
Finitura Esterna Cappotto

ESEMPIO
DI CONFIGURAZIONE
SPALLA 491 / 491Z
SOTTOBANCALE 20J

SEZIONE VERTICALE

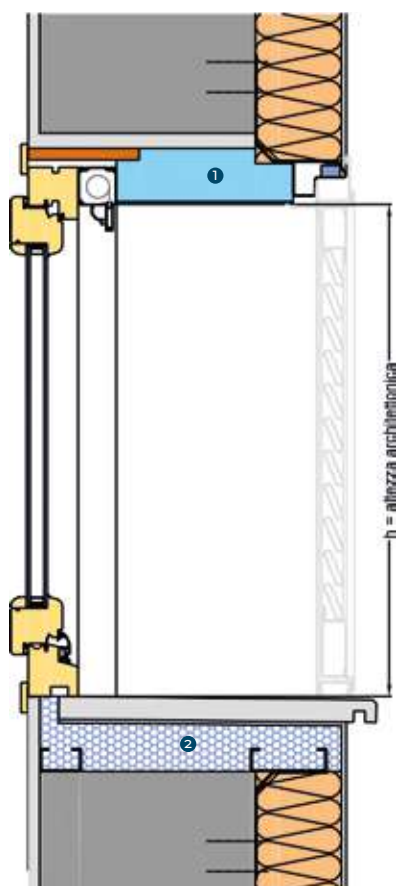

ELEMENTI

- 1 TRAVERSA
- 2 SOTTOBANCALE
- 3 SPALLA
- 4 PREDISPOSIZIONE ZANZARIERA
- 5 STAFFA DI FISSAGGIO

MATERIALI

- XPS CAM
- EPS CAM
- OSB
- FIBROCEMENTO
- CAPPOTTO

SEZIONE ORIZZONTALE

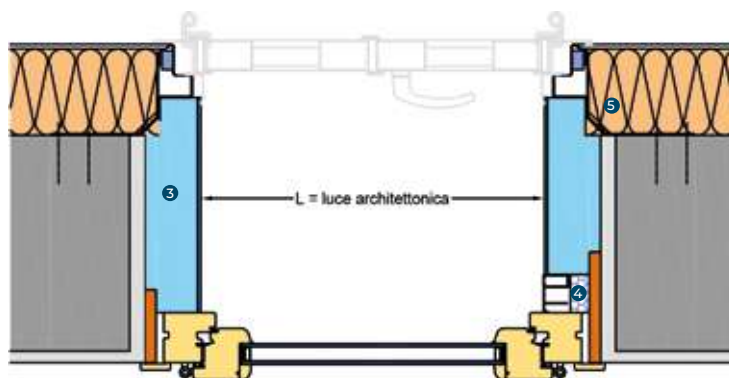

PAG. 171



PAG. 217



PAG. 201

SPALLA

SPALLA STANDARD PREFINITA

MODELLO 491

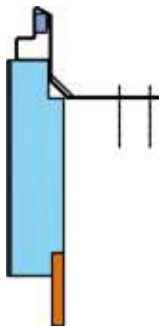

SPALLA RINFORZATA PREFINITA

MODELLO 441

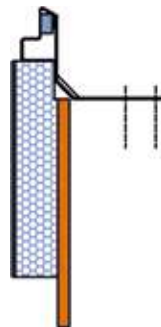

SPALLA RINFORZATA A RASARE

MODELLO 421

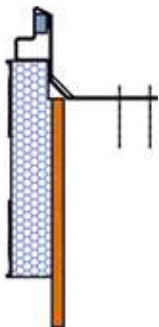

Z - SEDE ZANZARIERA

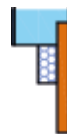

VARIANTE SENZA COPRIFILO
(Solo Persiane/Grate Eco apribili)



SOTTOBANCALE

con fibrocemento

MODELLO 10G

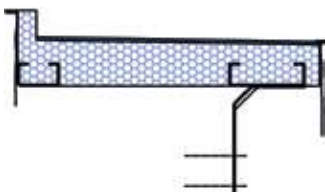

senza fibrocemento

MODELLO 20J

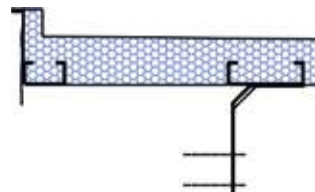

MODELLO 5

listello taglio termico

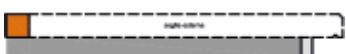

MONOBLOCCO

Serramento Persiana / Grata Eco
Finitura Esterna Facciavista

ESEMPIO
DI CONFIGURAZIONE
SPALLA 491 / 491Z
SOTTOBANCALE 20

SEZIONE VERTICALE

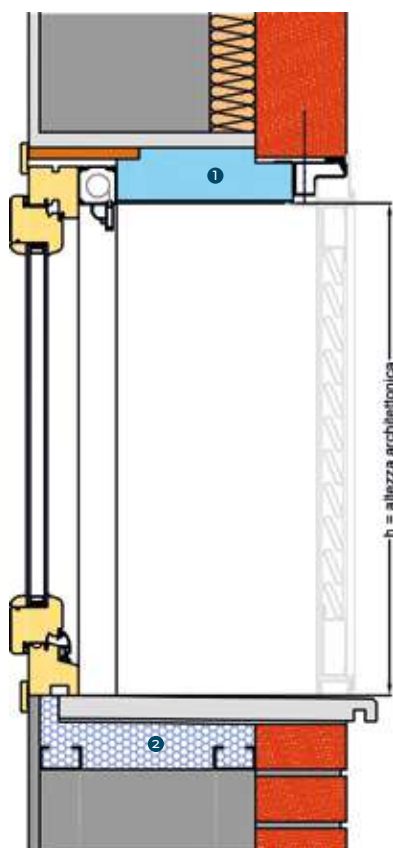

ELEMENTI

- ① TRAVERSA
- ② SOTTOBANCALE
- ③ SPALLA
- ④ PREDISPOSIZIONE ZANZARIERA

MATERIALI

- XPS CAM
- EPS CAM
- OSB
- FIBROCEMENTO
- MATTONE

SEZIONE ORIZZONTALE

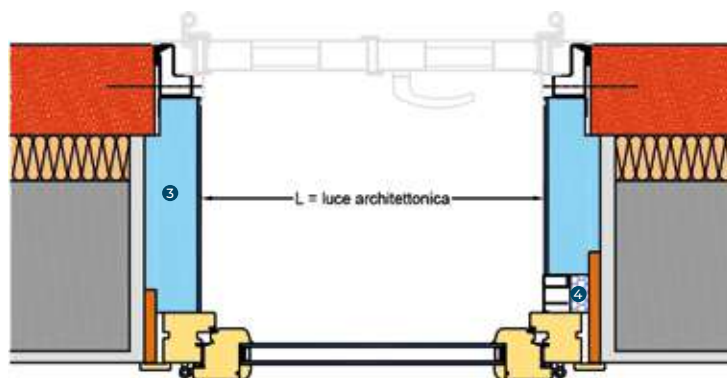

PAG. 171



PAG. 217



PAG. 201

SPALLA

SPALLA STANDARD PREFINITA

MODELLO 491

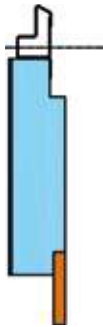

SPALLA RINFORZATA PREFINITA

MODELLO 441

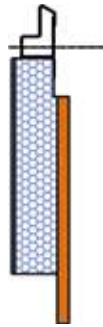

SPALLA RINFORZATA A RASARE

MODELLO 421



Z - SEDE ZANZARIERA

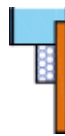

VARIANTE SENZA COPRIFILO
(Solo Persiane/Grate Eco apribili)



SOTTOBANCALE

con fibrocemento

MODELLO 10

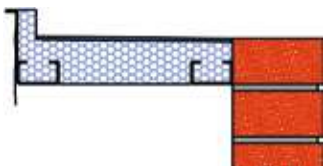

senza fibrocemento

MODELLO 20

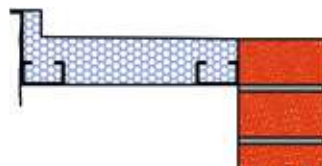

MODELLO 5

listello taglio termico

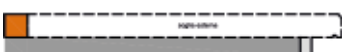

PERSIANA / SCURO

PERSIANA / GRATA ECO

FACCIAVISTA

MONOBLOCCO

Serramento Combinata Eco
Finitura Esterna Intonaco

ESEMPIO
DI CONFIGURAZIONE
SPALLA 495 / 495Z
SOTTOBANCALE 201

SEZIONE VERTICALE

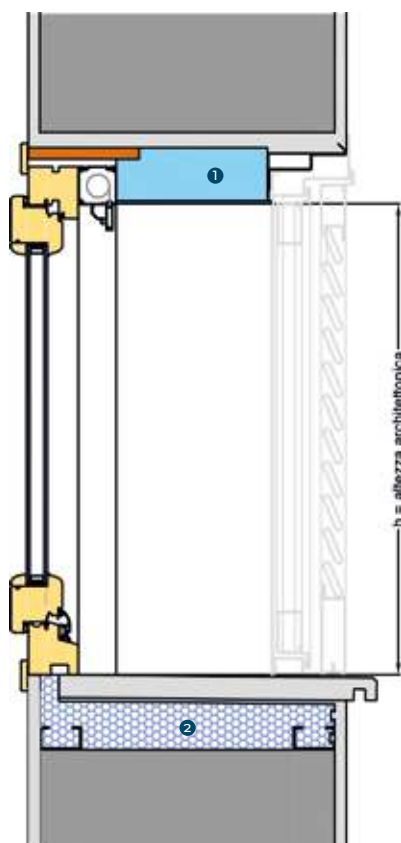

ELEMENTI

- ① TRAVERSA
- ② SOTTOBANCALE
- ③ SPALLA
- ④ PREDISPOSIZIONE ZANZARIERA

MATERIALI

- XPS CAM
- EPS CAM
- OSB
- FIBROCEMENTO
- INTONACO

SEZIONE ORIZZONTALE

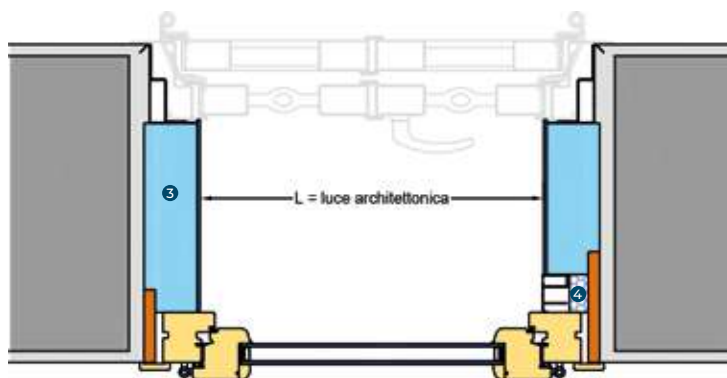

PAG. 171



PAG. 217



PAG. 201

SPALLA

SPALLA STANDARD PREFINITA

MODELLO 495

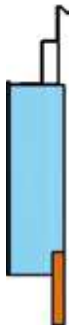

SPALLA RINFORZATA PREFINITA

MODELLO 445

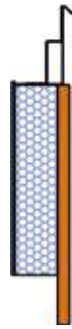

SPALLA RINFORZATA A RASARE

MODELLO 425

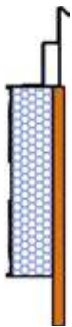

Z - SEDE ZANZARIERA

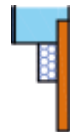

SOTTOBANCALE

con fibrocemento

MODELLO 10F



senza fibrocemento

MODELLO 20I



MODELLO 5

listello taglio termico

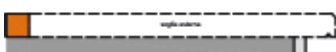

MONOBLOCCO

Serramento Combinata Eco
Finitura Esterna Cappotto

ESEMPIO
DI CONFIGURAZIONE
SPALLA 495 / 495Z
SOTTOBANCALE 20J

SEZIONE VERTICALE

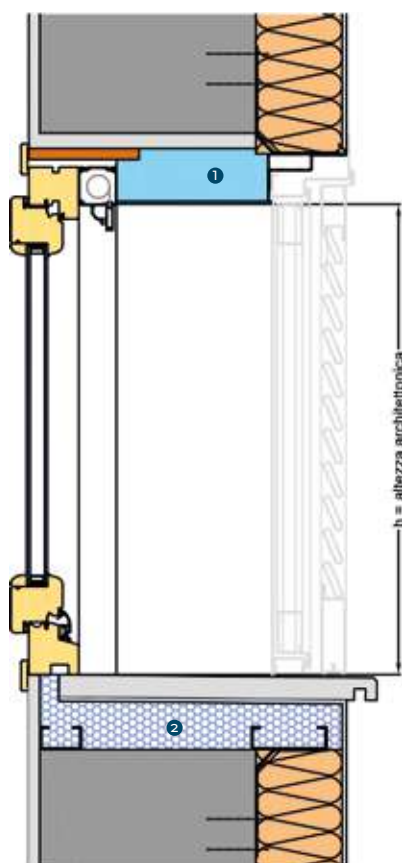

ELEMENTI

- 1 TRAVERSA
- 2 SOTTOBANCALE
- 3 SPALLA
- 4 PREDISPOSIZIONE ZANZARIERA
- 5 STAFFA DI FISSAGGIO

MATERIALI

- XPS CAM
- EPS CAM
- OSB
- FIBROCEMENTO
- CAPPOTTO

SEZIONE ORIZZONTALE

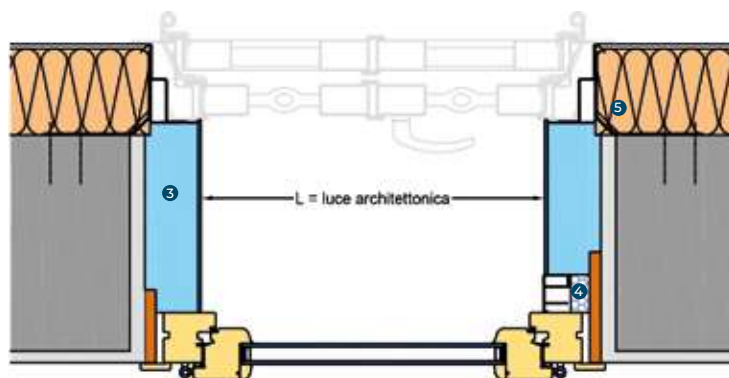

SPALLA

SPALLA STANDARD PREFINITA

MODELLO 495

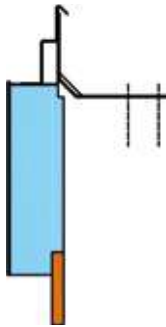

SPALLA RINFORZATA PREFINITA

MODELLO 445

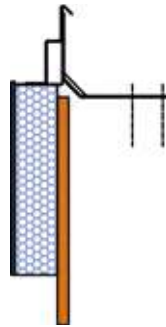

SPALLA RINFORZATA A RASARE

MODELLO 425

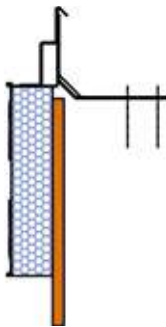

Z - SEDE ZANZARIERA

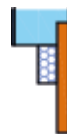

SOTTOBANCALE

con fibrocemento

MODELLO 10G

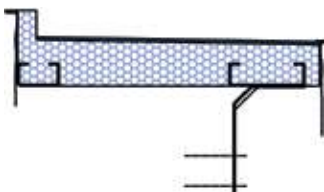

senza fibrocemento

MODELLO 20J

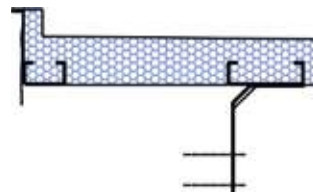

MODELLO 5

listello taglio termico

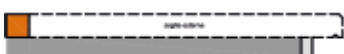

MONOBLOCCO

Serramento Combinata Eco
Finitura Esterna Facciavista

ESEMPIO
DI CONFIGURAZIONE
SPALLA 495 / 495Z
SOTTOBANCALE 20

SEZIONE VERTICALE

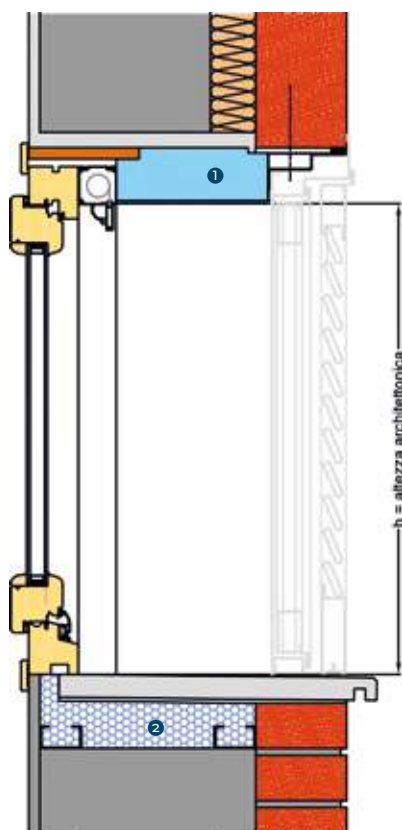

ELEMENTI

- ① TRAVERSA
- ② SOTTOBANCALE
- ③ SPALLA
- ④ PREDISPOSIZIONE ZANZARIERA

MATERIALI

- XPS CAM
- EPS CAM
- OSB
- FIBROCEMENTO
- MATTONE

SEZIONE ORIZZONTALE

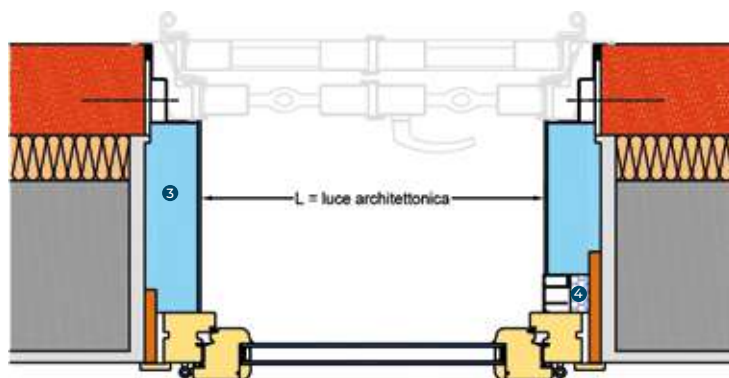

PAG. 171



PAG. 217



PAG. 201

SPALLA

SPALLA STANDARD PREFINITA

MODELLO 495

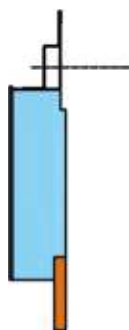

SPALLA RINFORZATA PREFINITA

MODELLO 445

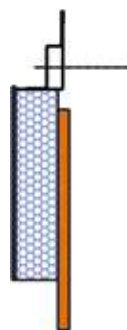

SPALLA RINFORZATA A RASARE

MODELLO 425

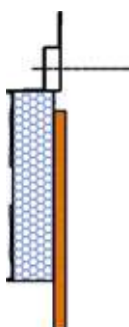

Z - SEDE ZANZARIERA



SOTTOBANCALE

con fibrocemento

MODELLO 10

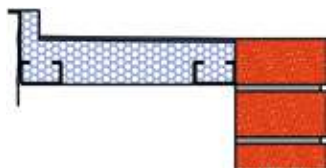

senza fibrocemento

MODELLO 20

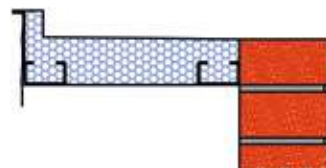

MODELLO 5

listello taglio termico

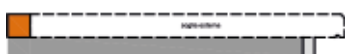

PERSIANA / SCURO

COMBINATA ECO

FACCIAVISTA